

# **RIGOL**

## **User Guide**

### **PVA8000 Series Active Probe**

**Jan. 2022**

**RIGOL TECHNOLOGIES CO., LTD.**

# Guaranty and Declaration

## Copyright

© 2022 **RIGOL** TECHNOLOGIES CO., LTD. All Rights Reserved.

## Trademark Information

**RIGOL**® is the trademark of **RIGOL** TECHNOLOGIES CO., LTD.

## Publication Number

UGE32100-1110

## Notices

- **RIGOL** products are covered by P.R.C. and foreign patents, issued and pending.
- **RIGOL** reserves the right to modify or change parts of or all the specifications and pricing policies at the company's sole decision.
- Information in this publication replaces all previously released materials.
- Information in this publication is subject to change without notice.
- **RIGOL** shall not be liable for either incidental or consequential losses in connection with the furnishing, use, or performance of this manual, as well as any information contained.
- Any part of this document is forbidden to be copied, photocopied, or rearranged without prior written approval of **RIGOL**.

## Product Certification

**RIGOL** guarantees that this product conforms to the national and industrial standards in China as well as the ISO9001:2015 standard and the ISO14001:2015 standard. Other international standard conformance certifications are in progress.

## Contact Us

If you have any problem or requirement when using our products or this manual, please contact **RIGOL**.

E-mail: [service@rigol.com](mailto:service@rigol.com)

Website: [www.rigol.com](http://www.rigol.com)

# Safety Notices and Symbols

## Safety Notices in this Manual:



---

### **WARNING**

Indicates a potentially hazardous situation or practice which, if not avoided, will result in serious injury or death.

---



---

### **CAUTION**

Indicates a potentially hazardous situation or practice which, if not avoided, could result in damage to the product or loss of important data.

---

## Safety Terms on the Product:

**DANGER** It calls attention to an operation, if not correctly performed, could result in injury or hazard immediately.

**WARNING** It calls attention to an operation, if not correctly performed, could result in potential injury or hazard.

**CAUTION** It calls attention to an operation, if not correctly performed, could result in damage to the product or other devices connected to the product.

## Safety Symbols on the Product:



Hazardous  
Voltage



Safety  
Warning



Protective  
Earth  
Terminal



Chassis  
Ground



Test Ground

# Document Overview

This document is used to guide users to get a quick understanding of the PVA8000 series active probe as well as its using method. Besides, this document gives service information relating to care and cleaning.

PVA8000 series active probe includes the following models.

Model	Bandwidth
PVA8350	>3.5 GHz
PVA8700	>7 GHz

Main topics:

- **PVA8000 Series Overview**

This chapter gives a brief introduction of the probe, including general inspection, probe dimensions, standard accessories, and etc.

- **To Use PVA8000 Series Active Probe**

This chapter introduces how to use the probe, including how to connect to the oscilloscope, how to use the probe head, how to replace probe accessories, how to adjust the offset voltage, how to calibrate the probe, and etc.

- **Care and Cleaning**

- **Warranty**

- **Specifications**

# Contents

- Guaranty and Declaration ..... I**
- Safety Notices and Symbols ..... II**
- Document Overview ..... III**
- PVA8000 Series Overview ..... 1**
  - Probe Introduction ..... 2
  - General Inspection ..... 3
  - Probe Dimensions ..... 4
  - Accessories and Options ..... 5
  - Active Probe Amplifier ..... 7
  - Probe Head ..... 8
- To Use PVA8000 Series Active Probe ..... 13**
  - To Connect to the Oscilloscope ..... 14
  - To Use the Probe Head ..... 17
  - To Replace Probe Accessories ..... 22
  - To Adjust Offset Voltage ..... 23
  - To Calibrate the Probe ..... 24
- Care and Cleaning ..... 25**
- Warranty ..... 26**
- Specifications ..... 27**

# PVA8000 Series Overview

This chapter guides users to quickly get familiar with the PVA8000 series active probe.

Main topics:

- Probe Introduction
- General Inspection
- Probe Dimensions
- Accessories and Options
- Active Probe Amplifier
- Probe Head

## **Probe Introduction**

PVA8000, with more than 7 GHz bandwidth, is an active probe for high frequency application. It can be used to measure differential and single-ended signals with better common mode rejection. PVA8000 uses plug-on socket probe head and supports four types of interchangeable probe heads to cater to different application scenarios, improving its usability. Besides, its replaceable probe tip prolongs the service life of the probe and the probe tip spacing can be precisely adjusted to fit different test point spacing.

PVA8000 is compatible with the auto-identification port of **RIGOL** DS70000 series oscilloscope and can be recognized and configured automatically. Its snap-in BNC connector enables easier connection with the oscilloscope.

PVA8000 provides various accessories and options, as well as multiple replaceable components which make it applicable to be used in different tests and measurements.

## General Inspection

### 1. **Inspect the packaging**

If the packaging has been damaged, do not dispose the damaged packaging or cushioning materials until the shipment has been checked for completeness and has passed both electrical and mechanical tests.

The consigner or carrier shall be liable for the damage to the instrument resulting from shipment. **RIGOL** would not be responsible for free maintenance/rework or replacement of the instrument.

### 2. **Inspect the instrument**

In case of any mechanical damage, missing parts, or failure in passing the electrical and mechanical tests, contact your **RIGOL** sales representative.

### 3. **Check the accessories**

Please check the accessories according to the packing lists. If the accessories are damaged or incomplete, please contact your **RIGOL** sales representative.



# Probe Dimensions

**Figure 1** shows the dimensions of the probe body of PVA8000 series active probe.

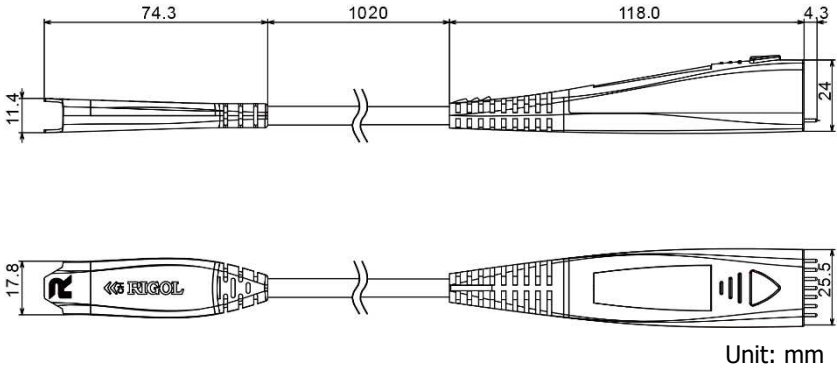

Figure 1 Probe Dimensions

## Accessories and Options

This section lists the probe kits and standard accessories of the PVA8000 series active probe respectively. All the components listed below can be ordered from **RIGOL**.

- PVA8700 Active Probe Kit contains all the accessories listed in **Table 1**. If any accessory or option needs to be ordered separately, please refer to **Table 1**.
- PVA8350 Active Probe Kit contains all the accessories listed in **Table 2**. If any accessory or option needs to be ordered separately, please refer to **Table 2**.

Table 1 PVA8700 Active Probe Kit Standard Accessories

Name	Qty.
PVA8700 Active Probe Amplifier	1
Solder-in Differential Probe Head	1
Solder-in Single-ended Probe Head	1
Hand-held Differential Probe Head	1
Hand-held Single-ended Probe Head	1
0.2mm Nickel Wire	1
Trim Gauge	1
Ground Pin (Hand-held Single-ended)	4 types (3 pcs for each type)
Signal Pin (Hand-held Single-ended)	3 types (3 pcs for each type)
Probe Tip (Hand-held Differential)	1 type (3 pcs)
User Guide	1
Storage Box	1
Probe Bag	1

Table 2 PVA8350 Active Probe Kit Standard Accessories

<b>Name</b>	<b>Qty.</b>
PVA8350 Active Probe Amplifier	1
Solder-in Differential Probe Head	1
Solder-in Single-ended Probe Head	1
Hand-held Differential Probe Head	1
Hand-held Single-ended Probe Head	1
0.2mm Nickel Wire	1
Trim Gauge	1
Ground Pin (Hand-held Single-ended)	4 types (3 pcs for each type)
Signal Pin (Hand-held Single-ended)	3 types (3 pcs for each type)
Probe Tip (Hand-held Differential)	1 type (3 pcs)
User Guide	1
Storage Box	1
Probe Bag	1

**Note:** The accessories listed in this section are only for reference, take the actual product as the standard.

## Active Probe Amplifier

The active probe amplifier (**Figure 2**), with more than 7 GHz bandwidth, is a main component of the active probe. One end of the active probe amplifier can be connected to the oscilloscope (e.g. DS70000 series) and the other end can be connected to the desired probe head.

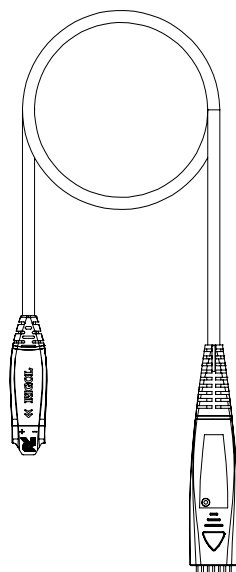

Figure 2 Active Probe Amplifier

When connecting a **probe head** to an **active probe amplifier**, push it straight in. When plugging in, make sure that the active probe amplifier is tightly connected to the probe head via the connection points. Pay attention to the spring direction, if connected in the wrong direction, the performance of the active probe will be undermined, even worse, the probe may be damaged.



**CAUTION**

There is a black mark sleeve on the negative pole of the solder-in single-ended probe head.

---

## Probe Head

PVA8000 supports **hand-held probe head** and **solder-in probe head**.

### 1. Hand-held Probe Head

The types of hand-held probe head include: **hand-held differential probe head and hand-held single-ended probe head**.

Like using common passive probes, you can use this kind of probe head to easily measure signals. Besides, the spacing between the probe tips can be easily adjusted to fulfill your various measurement requirements.

For hand-held differential probe head, the spacing between the probe tips is controlled by the roller on the probe head. As shown in **Figure 3**, turning the roller forwards or backwards can precisely adjust the spacing between the two probe tips.

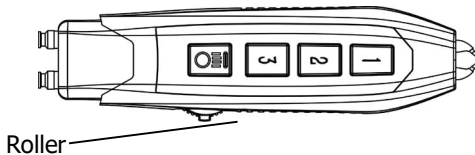

Figure 3 Hand-held Differential Probe Head

As shown in **Figure 4**, the probe tip is a standard accessory and replaceable. If it is damaged during use, you can easily replace it with a new one (refer to **To Replace Probe Accessories**).

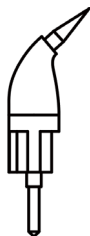

Figure 4 Probe Tip

For hand-held single-ended probe head, rotating the ground pin can adjust the spacing between the ground pin and probe tip, as shown in **Figure 5**.

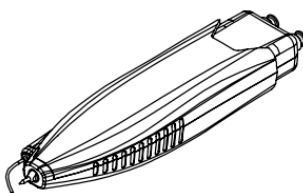

Figure 5 Hand-held Single-ended Probe Head

The signal pin and the ground pin are standard accessories. There are different types of signal pins and the ground pins, and they are replaceable. You can use them according to different application scenarios (refer to **To Replace Probe Accessories**).

PVA8000 series probe provides three types of signal pins and four types of ground pins to cater to different test requirements. The structure of the pins are shown in **Figure 6**. Different types of signal pins and ground pins can work with each other in different combination forms.

#### Signal Pin Types

a) Signal Pin (bent): (same as the hand-held differential probe tip, available to

use for any hand-held differential probe): suitable for carrying out the handheld spot test for near-distance test points.

b) Signal Pin (straight): suitable for the hand-held spot test for near-distance test points.

c) Signal Adapter (square pin): work with Male Dupont wires, suitable for measurements of a longer distance of test points; or work with square pin ground adapter, suitable for in-line circuit board pin tests.

### Ground Pin Types

d) Ground Pin (pogo): suitable for the hand-held spot test for near-distance test points.

e) Ground Pin (solderable): suitable for the hand-held spot test for a longer distance of test points or soldering test.

f) Ground Adapter (square pin): work with the signal square pin adapter, suitable for in-line circuit board pin tests.

g) Ground Adapter (angled): works with male DuPont wires for measurements of a longer distance of test points.

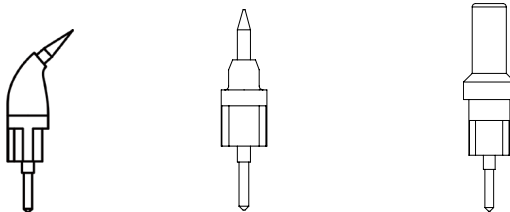

(a) Signal Pin (bent) (b) Signal Pin (straight) (c) Signal Adapter (square pin)

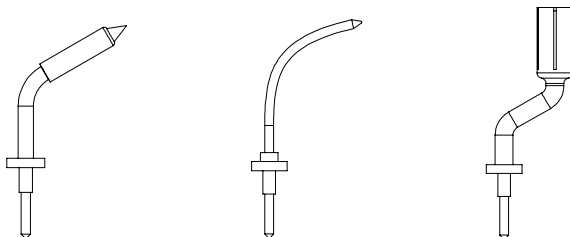

(d) Ground Pin (pogo) (e) Ground Pin (solderable) (f) Ground Adapter (square pin)

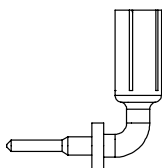

(g) Ground Adapter (angled)

Figure 6 Signal Pin Types and Ground Pin Types

## 2. Solder-in Probe Head

The solder-in probe head includes two types: **solder-in differential probe head** and **solder-in single-ended probe head**, as shown in **Figure 7** and **Figure 8**. Wherein, solder-in probe head is suitable for measurement of high-density IC pin signals.



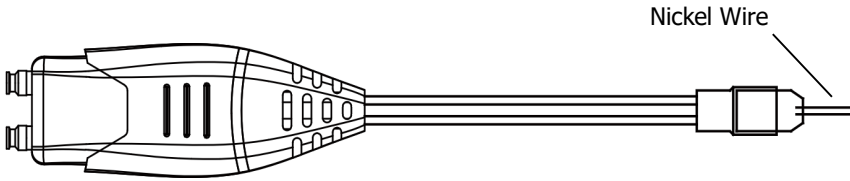

Figure 7 Solder-in Differential Probe Head

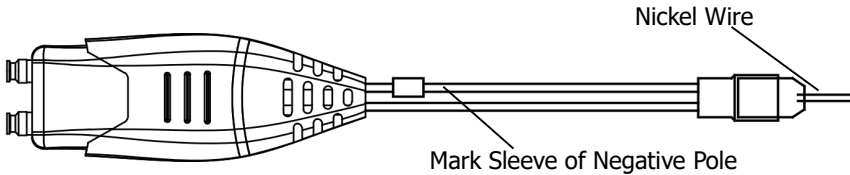

Figure 8 Solder-in Single-ended Probe Head

The pin that is at the same side of the mark sleeve is used to connect to the ground.

When using the solder-in probe head for measurement, we recommend you to use an auxiliary device to fix the probe head.



**CAUTION**

Using your hand to fix the probe head may cause the lead resistor soldered onto the probe head to break or fall off. The hand-held position might also affect the probe performance!

---

The nickel wire of the solder-in probe head is a standard accessory. If the nickel wire under use is damaged or broken, please replace it with a new one (refer to **To Replace Probe Accessories**).

# To Use PVA8000 Series Active Probe

During the use of PVA8000 series active probe, correct operations can ensure the probe performance, prolong the service life of the probe and ensure the effectiveness of the signal measurement result. This chapter introduces in detail the using method of the PVA8000 series active probe.

Main Topics:

- To Connect to the Oscilloscope
- To Use the Probe Head
- To Replace Probe Accessories
- To Adjust Offset Voltage
- To Calibrate the Probe

## To Connect to the Oscilloscope

After PVA8000 is connected correctly to a **RIGOL** DS70000 series oscilloscope, the oscilloscope recognizes the probe automatically and provides both power and offset voltage to the probe. You can adjust the offset voltage (refer to **To Adjust Offset Voltage**) and calibrate the probe (refer to **To Calibrate the Probe**) by the front panel menu of the oscilloscope.

Please connect the probe to the oscilloscope following the steps below:

1. Connect the probe head (in the figure, taking a hand-held differential probe head for example) with the active probe amplifier.

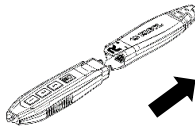

2. Connect the other end of the active probe amplifier to the channel input connector of the oscilloscope and make sure the connection is tight.

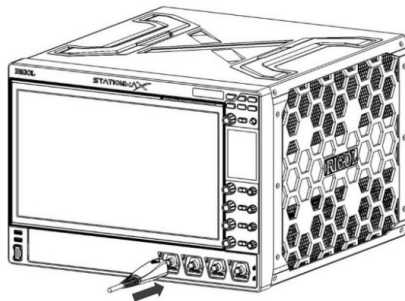

3. Use any probe auxiliary device to connect the probe to the circuit to be tested.

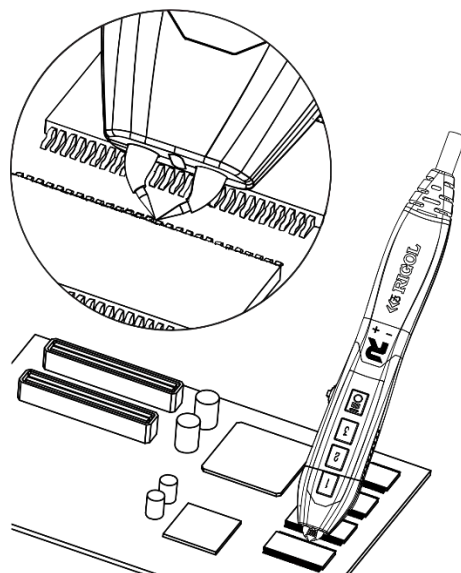

4. To disconnect the probe from the oscilloscope, press the button on the probe (as shown in the left figure below), pull the connector straight out of the oscilloscope (as shown in the right figure below) and then release the button.

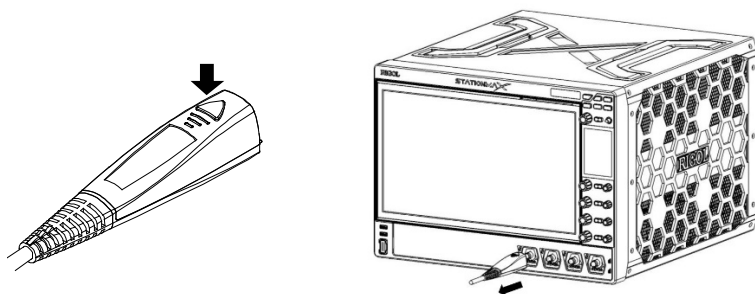



---

**CAUTION**

Do not twist the probe on the BNC connector of the oscilloscope. Otherwise, the probe might be damaged.

---

## To Use the Probe Head

In the **Probe Head** section, PVA8000 can be connected with 4 types of probe heads. You can easily change the probe head by using the method introduced in **To Replace Probe Accessories**. This chapter introduces how to use these probe heads respectively.

### 1. Hand-held Differential Probe Head

The hand-held differential probe head provides an effective bandwidth of more than 7 GHz. The spacing between the two probe tips can be precisely adjusted by turning the roller. You can also use the button on the probe head to make adjustment according to the existing adjustment history memory. The probe tips are replaceable, which can prolong the service life of the probe.

The structure of the hand-held differential probe head is shown in **Figure 9**.

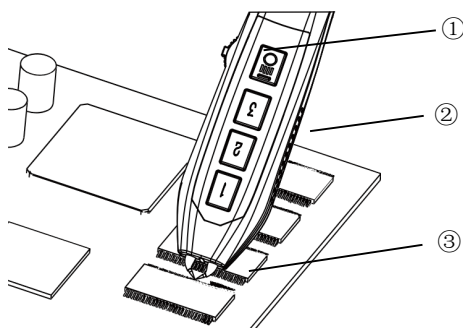



Figure 9 Hand-held Differential Probe Head

- ① Turning the roller to adjust the spacing (0.2 mm to 5.4 mm) between

the two probe tips.

- ② Hand-held differential probe head.
- ③ probe tip.

The hand-held differential probe head can be used to measure differential and single-ended signals. Button 1, 2, and 3 on the probe head has the memory function. Take Button 1 as an example. When you need to save the current position of the probe head for future use, long press this button in this position until the indicator between the probe tips blinks. Then release the button. In this way, the position of the probe tip is remembered by the probe. For the future use, once you want to adjust the probe to this specified position, just press Button 1 and then the probe tip will be adjusted

automatically to this position. The  button is a button for controlling the on/off status of the indicator located between the probe tips. In weak light environment, you'd better turn on the indicator to make measurements clear to see.

The following figure shows the operation demonstration:

Long press the roller in this direction to close the probe tips.

Press down the roller to restore the probe tips to its original position.

Long press the roller in this direction to make the tips open.

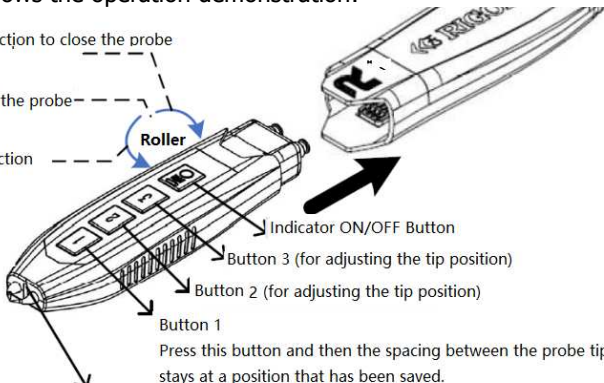

**Indicator:** used for measurement in weak light environment. When it blinks, the spacing between probe tips is saving.

Press this button and then the spacing between the probe tips stays at a position that has been saved.  
Long press this button for 3 seconds, the current spacing is saved and the indicator blinks.

Figure 10 How to Operate the Hand-held Differential Probe Head

## 2. Hand-held Single-ended Probe Head

The hand-held single-ended probe head provides an effective bandwidth of more than 7 GHz. The spacing between the signal pin of the probe and the ground pin can be adjusted by moving or rotating the ground pin. The signal pin (hand-held single-ended) and ground pin (hand-held single-ended) are replaceable, improving its usability and prolonging the service life of the probe.

The structure of the hand-held single-ended probe head is shown in **Figure 11**.

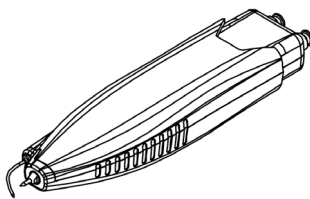

Figure 11 Hand-held Single-ended Probe Head

## 3. Solder-in Differential Probe Head

The solder-in differential probe head provides an effective bandwidth of more than 7 GHz. The replacement of the nickel wire enhances the usability of the probe and prolongs its service life.

The structure of the solder-in differential probe head is shown in **Figure 12**.



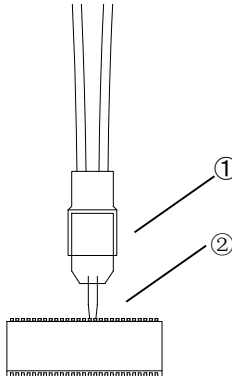

Figure 12 Solder-in Differential Probe Head

- ① Solder-in differential probe head.
- ② 0.2mm Nickel Wire (4 mm typ.).

When the points to be tested are widely spaced, the length of the nickel wire will be increased. At this point, overshoot and ringing will occur and the high-frequency response will change.

#### 4. Solder-in Single-ended Probe Head

The solder-in single-ended probe head provides an effective bandwidth of more than 5 GHz. The replacement of the nickel wire enhances the usability of the probe and prolongs its service life.

The structure of the solder-in single-ended probe head is shown in **Figure 13**.

The pin at the same side with the negative pole mark sleeve (refer to **Figure 8**) is negative.

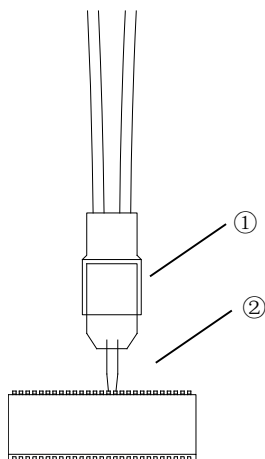

Figure 13 Solder-in Single-ended Probe Head

- ① Solder-in single-ended probe head.
- ② 0.2mm Nickel Wire (4 mm typ.).

When the points to be tested are widely spaced, the length of the nickel wire will be increased. At this point, overshoot and ringing will occur and the high-frequency response will change.

## To Replace Probe Accessories

### 1. To replace the probe head

Take care not to damage the connecting part to avoid affecting the probe performance when replacing the probe head.

Replacing Method:

- ① Disconnect the connection between the probe and the oscilloscope.
- ② Disconnect the current probe head from the active probe amplifier.
- ③ Push the new probe head into the active probe amplifier straightly.  
When single-ended probe head is used, keep the spring contact at the same side being connected.

### 2. To replace the probe tip

The probe tip can be inserted into the probe head directly, so please note the direction and strength when removing and installing the probe tip.

### 3. To replace the nickel wire

If the nickel wire of the solder-in probe head under use becomes damaged or breaks off, you can replace a new one. The probe head nickel wire should satisfy the following size requirement, that is, the length is 4 mm (recommended value).

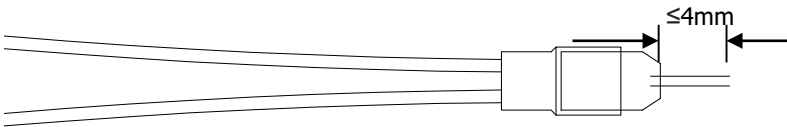

Note: If the length of the nickel wire is longer than 4 mm, the bandwidth specification of the probe will be affected. You can use the trim gauge to measure and cut the nickel wire.

## To Adjust Offset Voltage

**RIGOL** DS70000 series oscilloscope can provide offset voltage to the PVA8000 series active probe. Then the offset voltage can be output through the BNC module of the probe. The offset voltage adjusts the measured signal which exceeds the input dynamic range of the probe to within an appropriate range to ensure the measured signal's integrity.

You can adjust the offset voltage by operating the front panel menu of the oscilloscope. The operation method is as shown below.

1. Follow the instructions in **To Connect to the Oscilloscope** to connect the PVA8000 series active probe to the channel input terminal (e.g. CH1) of the DS70000 oscilloscope.
2. Open the probe offset voltage control menu of the DS70000 oscilloscope (**CH1** → **Probe** → **Bias**) and input the value with the virtual keypad.

## To Calibrate the Probe

Before using, you should calibrate the PVA8000 series active probe. Follow the procedures below to calibrate the PVA8000 active probe:

1. Connect the PVA8000 active probe to the analog channel (CH1 to CH4 of the oscilloscope, illustrations here are based on CH1).
2. Open the probe calibration control menu (front panel operation: **CH1** → **Probe** → **Calibration**), and the oscilloscope starts to calibrate the probe. The calibration will last for about 80 to 90 seconds. When the probe calibration is finished, a prompt message "Probe calibration finished!" or "Probe calibration failure!" is displayed in the user interface of the oscilloscope.

As the offset voltage of the PVA8000 series active probe is provided by the BNC module, after the first calibration, you do not need to calibrate it again before use next time.

Note: Technical specifications of the PVA8000 series active probe depend on the calibration operation. After the calibration is finished, the DC gain, offset voltage zero and offset gain will be calibrated. After inserting the probe, users can view the information about the vendor, model, serial number, and the last calibration time of the probe through the menu operation: **CH1** → **Probe**.

---

## Care and Cleaning

### Care

Do not place the probe and its accessories in places where they will be exposed to sun light for long periods of time.



---

#### **CAUTION**

Keep the probe and its accessories away from any corrosive liquid.

---

### Cleaning

Clean the probe and its accessories regularly according to their operation conditions using the method below.

1. Disconnect the probe from the oscilloscope or power source.
2. Clean the external surfaces of the probe and its accessories with a soft cloth dampened with mild detergent or water.



---

#### **WARNING**

To avoid short-circuit resulting from moisture or even personal injuries, ensure that the probe is completely dry before use.

---

# Warranty

**RIGOL** TECHNOLOGIES CO., LTD. (hereinafter referred to as **RIGOL**) warrants that the product will be free from defects in materials and workmanship within the warranty period. If a product proves defective within the warranty period, **RIGOL** guarantees free replacement or repair for the defective product.

To get repair service, please contact with your nearest **RIGOL** sales or service office.

There is no other warranty, expressed or implied, except such as is expressly set forth herein or other applicable warranty card. There is no implied warranty of merchantability or fitness for a particular purpose. Under no circumstances shall **RIGOL** be liable for any consequential, indirect, ensuing, or special damages for any breach of warranty in any case.

# Specifications

## Technical Specifications

Item	PVA8350	PVA8700
Bandwidth	>3.5 GHz	>7 GHz
Rise Time	110 ps (typ.)	70 ps (typ.)
System Bandwidth	3.5 GHz <sup>[1]</sup>	5 GHz <sup>[1]</sup>
Input Capacitance	<0.6 pF	
Input Resistance	50kΩ±2% Differential	
	25kΩ±4% Single-ended	
Input Dynamic Range	±2 V	
Input Common Mode Range	±6.25 V DC to 100 Hz	
	±1.25 V >100 Hz	
Common Mode Rejection Ratio	>40dB@1MHz	>40 dB@1 MHz
	>26dB@1GHz	>26 dB@1 GHz
	>22dB@3GHz	>20 dB@4 GHz
SR <sub>max</sub> <sup>[2]</sup>	18 V/ns Single-ended	
	30 V/ns Differential	
DC Attenuation	10:1 ±2%	
Zero Offset Error <sup>[3]</sup>	<30mV before calibration	
	<5mV after calibration	
Offset Accuracy <sup>[3]</sup>	<3% of current range before calibration	
	<1% of current range after calibration	
Input Noise	5 mVrms	
Transmission Delay	6 ns (typ.)	



Max Input Voltage	30V Peak CAT I <sup>[4]</sup>
Electrostatic Protection (HBM)	>8 kV

### General Characteristics

Environmental Conditions	Operating	Non-operating
Temperature	+5°C to +40°C	-40°C to +60°C
Humidity	0 RH to 80% RH	0 RH to 90% RH
Altitude	4600m	15300m
Power Consumption	1.35W	N/A
Weights	137g±10g <sup>[5]</sup> 736g±50g <sup>[6]</sup>	
Wire Length	1 m	

- [1] System bandwidth when working with DS70000 series products.
- [2]  $SR_{max}$  of a sine wave =  $2 \times (\text{Amp} \times \text{Frequency})$ ;  $SR_{max}$  of a step =  $0.6 \times \text{Amp}/\text{Rise Time}$  (20% to 80%).
- [3] Typical value. The specifications would change when different scales are selected.
- [4] CAT I and CAT II Definitions  
 Installation Category (Overvoltage Category) I: signal level, special equipment or parts of equipment, telecommunication, electronic, etc., with smaller transient voltages than installation category (Overvoltage Category) II.  
 Installation Category (Overvoltage Category) II: local level, appliance, portable equipment etc., with smaller transient voltages than installation category (Overvoltage Category) III.
- [5] The weight of the PVA8000 probe with the hand-held differential probe head.
- [6] The weight of the PVA8000 series active probe kit with the probe bag.